

Compendium of accessible WASH technologies

Hazel Jones and Jane Wilbur (2014)

Further resources

Handwashing

Waterpoints

Bathing

Latrines

Reaching facilities



Introduction

- This compendium is designed for use by staff working directly with communities - e.g. health workers and community volunteers working with disabled and older people and their families in rural areas of sub-Saharan Africa.
- A few examples of technologies are presented that families can adapt to suit their needs and budgets. Many more options are possible.
- Most of the ideas are suitable for disabled and older people, but are not **only** for them. As we get older, many of us find it increasingly difficult to squat and balance, or we might be injured or sick. These technologies might also make facilities easier and more comfortable to use by everyone in the family.
- The ideas are designed to be suitable for household facilities, not for institutional facilities - e.g. schools and clinics - although some ideas might also be useful in these settings.
- This publication and all images in it are free to download here:
www.wateraid.org/accessibleWASHtechnologies

Image: Jones & Reed (2005)



Guidelines for use

The compendium can be used in various ways:

- As a starting point for discussion with households
- As a way of encouraging communities to consider design options
- By disabled people's organisations
- As flashcards - images can be enlarged and stuck on card
- As posters - images can be printed and used for group discussions

Technical specifications are not given, because all dimensions should be based on users' needs. The aim is to provide as much 'independent access' as possible - this means facilities that a person can use without help, or with minimum help.

If possible, try out ideas first to work out: how high a seat or support rail should be? How wide the entrance should be?

To work out how much space is needed inside a latrine, mark out the area on the ground using rocks or branches. Ask different users to try moving and squatting/sitting inside, and adjust if necessary.

Costs are not itemised because they will vary between communities. Instead, relative costs of each technology are suggested.

Paths

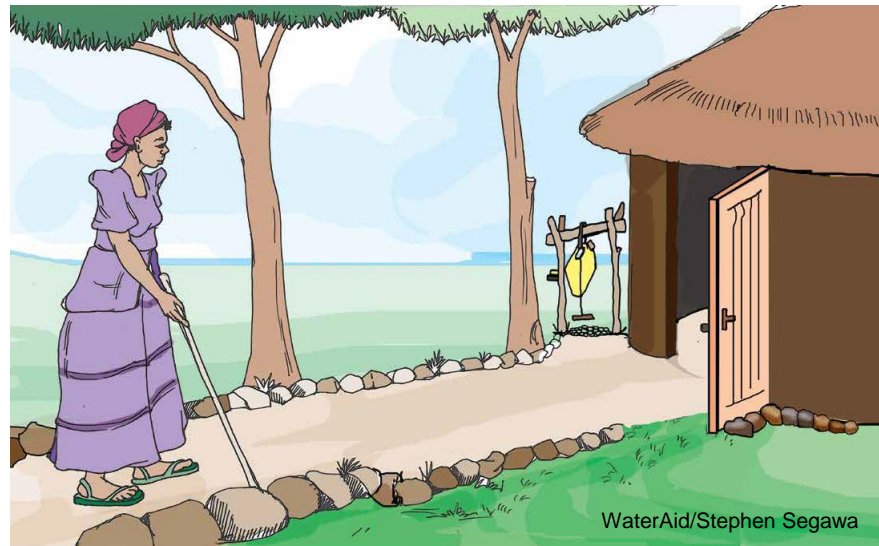

Paths

Suitable for: everyone, especially users with a visual impairment and with physical impairments, including wheelchair users.



Construction

Guide string from house to latrine and bath shelter

Advantages

- Easy to construct
- Simple to maintain
- Suitable for users with a visual impairment

Disadvantages

- Regular maintenance needed
- String must be carefully positioned so it is not a hazard to other users

Improvements/ variations

- Path could be lined with painted rocks or landmark posts

Cost / labour

Low



Clear, level path, lined with rocks

- Can be made according to budget
- Suitable for users with visual and physical impairments, including wheelchair users

- Rocks are easily moved or dislodged, which could cause a trip hazard
- Maintenance would include regular re-positioning of the rocks

- Paint rocks white or a bright colour to increase visibility

Low



Landmark posts made from local materials

- Can be made according to budget
- Easy to construct using local materials
- Provides guidance for users with a visual impairment

- Posts must be firm, and positioned so they are not a hazard to others
- Regular maintenance needed to check posts are stable

- Posts can be painted/marked with a bright colour to increase visibility
- Use alternative materials, e.g. rocks, or existing features, e.g. trees

Low to medium

Ramps



WaterAid/Jane Wilbur



HITS Uganda



Jones and Reed (2005)

Ramps

Suitable for: Users with physical impairments, wheelchair users, older people, people carrying heavy loads

Construction Advantages

Disadvantages

Improvements/ variations

Cost/ labour

Moveable wooden ramp for wheelchair to access facilities with steps

- Flexible – can be placed wherever needed
- Cheaper than concrete
- Raised sides prevent a wheelchair rolling off the side of the ramp

- Less durable than concrete
- User needs help to move the ramp when needed

- Paint raised sides white or bright colour to increase visibility

Medium

Wide concrete ramp to handpump apron

- The concrete ramp onto the apron improves access for everyone

- Ramp requires more space than steps
- Drainage must be in the opposite direction to keep the ramp dry
- Monitoring needed to ensure masons do not make it too steep to reduce cost

- Paint raised sides white or a bright colour to increase visibility
- Cross-hatching on ramp would make it less slippery when wet (see page 8 'Steps')

Medium

Low-gradient concrete ramp with raised sides for safety

- Smooth, firm, durable
- Gentle gradient so a child can propel her/himself up and make a controlled descent
- Raised sides prevent wheelchairs rolling off

- Monitoring of construction required to ensure gradient not too steep
- Maintenance needed to keep the ground the same level as the end of the ramp

- Paint raised sides white or bright colour to increase visibility

High



Ramps

Slope gradients and level of ease for different users

How gradient (slope) is measured

“Gradient” describes the change in height over a specified distance.

Example 1: Gradient 1 in 8

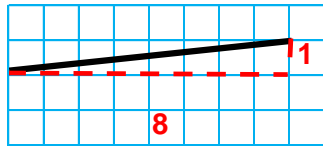

This slope rises one unit over a distance of eight units. For example, if the distance is 8m, the slope rises 1m. If the distance is 80cm, the slope rises 10cm. If the distance is 4m, the slope rises 0.5m. The gradient (slope) is the same, whether the distance is 8cm, 8 feet, 8m or 80m.

Example 2: Gradient 1 in 15

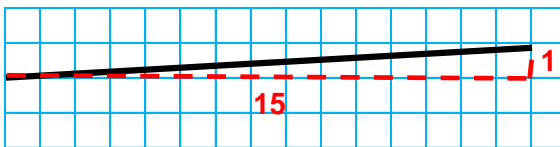

This slope rises 1 unit over a distance of 15 units. If the distance is 15m, the slope will rise 1m. How high will the slope rise if the distance is 30m? A. 30m? B. 10m? (Answers to the right)

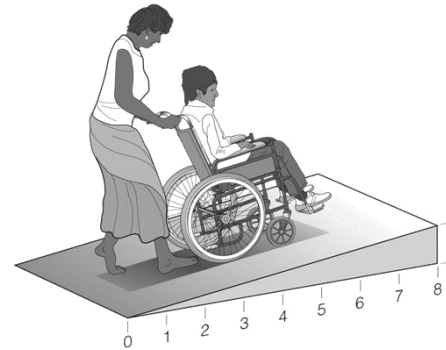

Very steep slope of 1 in 8 (not recommended)

Only suitable where a helper is always available

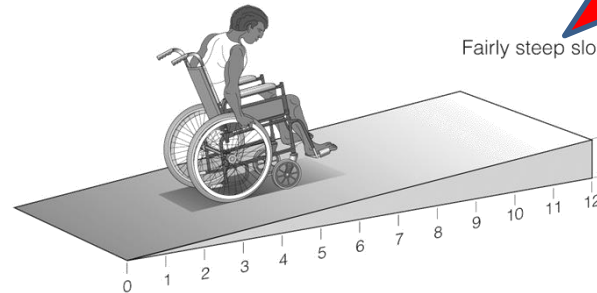

Fairly steep slope of 1 in 12

Absolutely no steeper than this

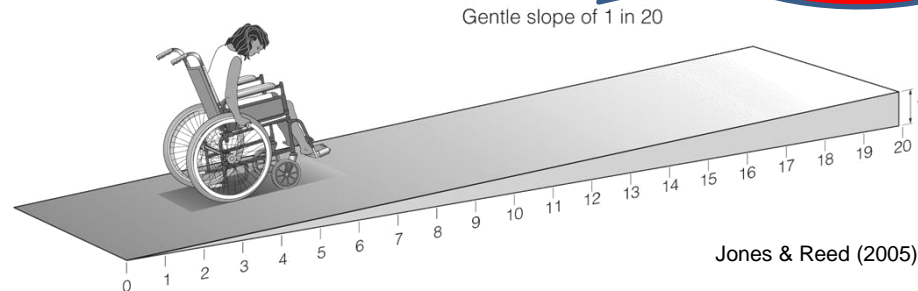

Gentle slope of 1 in 20

1 in 20 is ideal, but it needs a lot of space. 1 in 15 is a reasonable compromise.

Jones & Reed (2005)

Answers:
A. 2m
B. 66cm

Page deliberately left blank

Steps

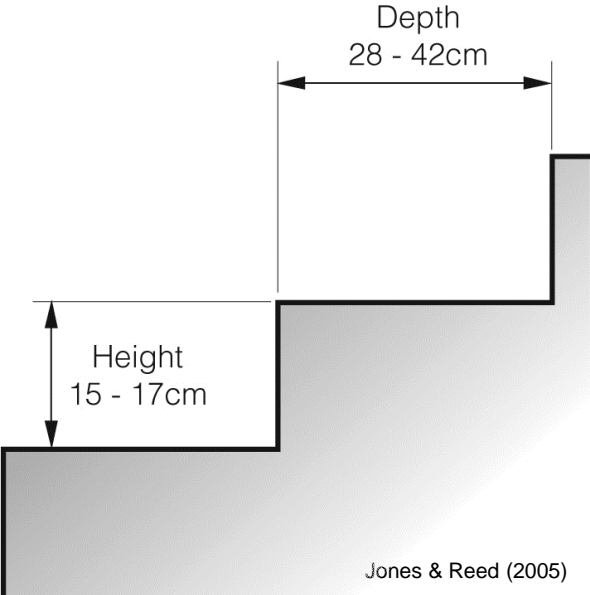
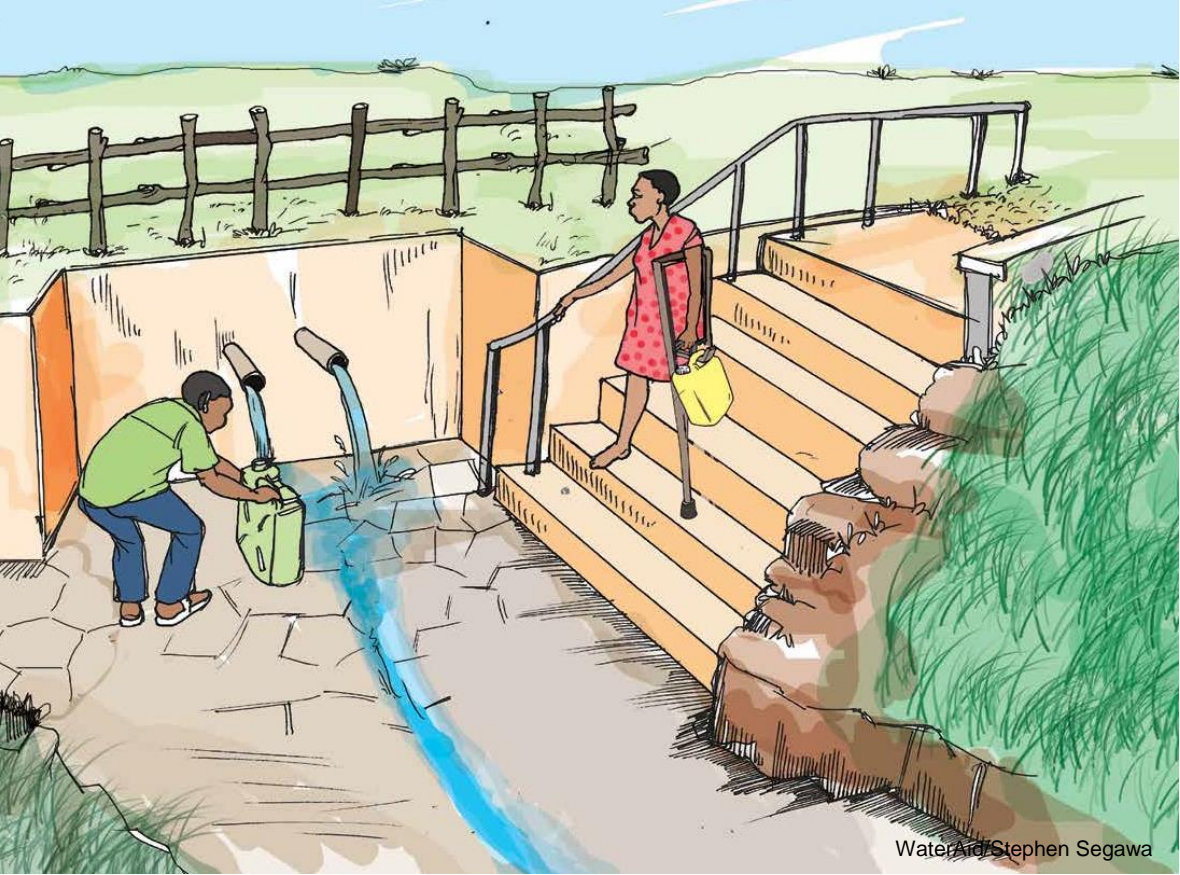

Steps

Suitable for: steep terrain; where space is limited; households or communities with no wheelchair users.

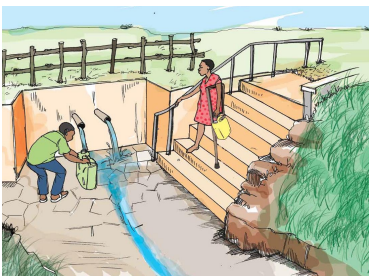
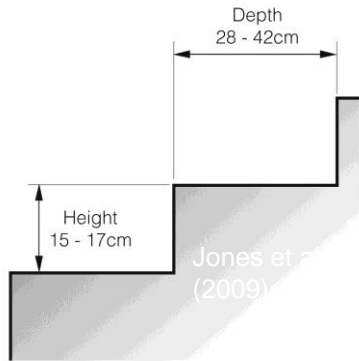

Construction	Advantages	Disadvantages	Improvements/ variations	Cost / labour
<p>Recommended step dimensions (for reference).</p> <p>Steps should be low and even – all the same height and depth.</p>	<ul style="list-style-type: none"> • Many users can manage low, even steps, especially when a handrail is provided. • Steps take up less space than a ramp. 	<ul style="list-style-type: none"> • Steps exclude some users, e.g. those using mobility devices. 	<ul style="list-style-type: none"> • Paint steps white or bright colour to increase visibility. 	
<p>Low concrete steps with cross-hatching to reduce the risk of slipping</p>	<ul style="list-style-type: none"> • Cross-hatching is easy to apply – the concrete is scored while wet. 	<ul style="list-style-type: none"> • No edge protection for unstable or visually impaired users 	<ul style="list-style-type: none"> • Steps should be of consistent height • Install a guard or handrail 	Low
<p>Handrail accompanying steps to a protected spring</p>	<ul style="list-style-type: none"> • Useful for all users • Might prevent injury from slipping on wet steps 	<ul style="list-style-type: none"> • Handrail needs maintenance to ensure it is stable and strong enough 	<ul style="list-style-type: none"> • Paint handrail and steps white or bright colour to increase visibility 	Medium

Movement aids

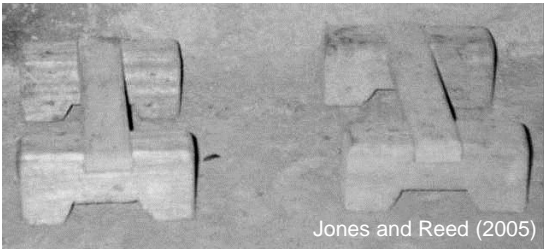

Movement aids

Suitable for: people who move by crawling; wheelchair users who need to get out of their wheelchair; or where a wheelchair is not available.

Construction	Advantages	Disadvantages	Improvements/ variations	Cost/ labour
--------------	------------	---------------	--------------------------	--------------

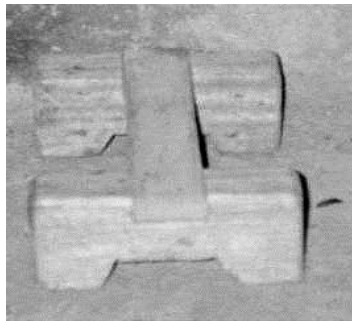

Wooden hand walkers

- Reduce abrasion, cuts and soiling of hands and thereby risk of infection
- Locally available materials
- Durable
- Easy to clean

- Lightweight wood would not be as durable as hardwood, so would need to be maintained and replaced more regularly.
- Brief initial demonstration might be needed

- Weight of wood can be selected to match the user's strength

Low



Rubber kneepads made from used car tyres. These fit over the knee, and rubber laces run through loops and tie around the leg.

- Reduce abrasion, cuts and soiling of knees and thereby risk of infection
- Durable
- Easy to clean

- Brief initial demonstration might be needed
- Regular maintenance and cleaning necessary

- An alternative design suitable for leg stumps is also available:

Low



Siting

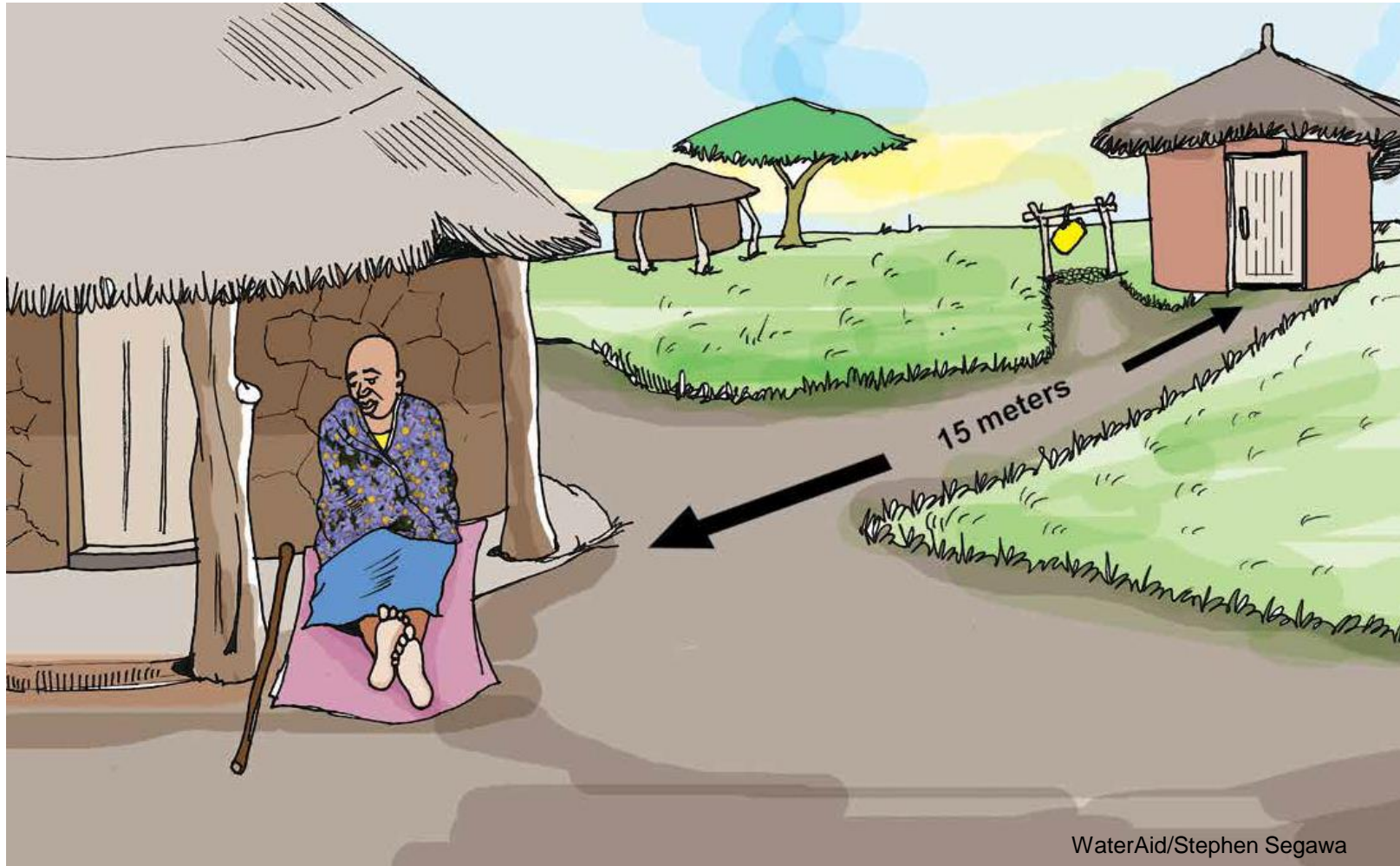

WaterAid/Stephen Segawa

Latrines should be no more than 15m from the household.

Page deliberately left blank

Superstructure



WaterAid Zambia/DAPP



WaterAid/ Hazel Jones



Jones and Reed (2005)

Superstructure

Suitable for: People with mobility impairments.

Construction Advantages

Grass walls attached to wooden poles; no roof; curtain for privacy.

- Materials locally available
- Easy and quick to construct
- Provides some privacy

Plastic sheeting for walls attached to wooden poles, woven mat for curtain, no roof.

- Materials locally available
- Easy and quick to construct
- Mat 'curtain' can be pulled across for privacy (see image)
- Wide entrance good for many users

Rammed earth structure with thatched roof

- Durable
- Materials locally available
- Strong enough to attach handrails to the wall

Disadvantages

- Low durability
- Lack of roof means it is difficult to use when raining or very hot
- Low privacy

- No roof means it is difficult to use when raining or very hot
- Curtain difficult to close
- Plastic sheeting easily damaged, reducing privacy

- Difficult to allow enough light in without reducing privacy

Improvements/ variations

- Useful as a temporary measure but not ideal long term
- Spiral construction with a wider entrance would provide greater privacy (see photo 1, *Handrails and support*)

- Plastic roof could be added

- Widen entrance
- Add a door with lock for privacy and security
- Increase number of windows (high up) to allow more light in

Cost/ labour

Low

Low

Medium to high



Entrances



Tom Russell/WEDC



Jones and Reed (2005)



BPKS Bangladesh

Entrances

Entrances must be: a) wide enough (wheelchair width + 20cm), and
b) level enough (minimal or no difference between outside and inside).

Construction

Advantages

Disadvantages

Improvements/ variations

Cost/ labour

Wide and level entrance to allow wheelchair access. Rammed earth floor.

- Can be easily accessed by everyone, including wheelchair users

- No door, so low privacy and security

- Add a door

Low to medium

Latrine with level concrete entrance, wide enough for a wheelchair user

- The floor of the latrine is the same level as the outside

- Level flooring could be achieved with any type of materials, not only concrete

Medium to high

Level concrete threshold with raised cement mound to reduce flooding. Mound is rounded for wheelchair access.

- Reduces water inflow without preventing wheelchair access

- Won't stop serious flooding!

Medium



Doors



Jones and Reed (2005)



WaterAid/CoU-TEDDO



Hazel Jones/WEDC

Doors

Suitable for: users with mobility devices, a helper, or carrying a small child, or people who are overweight.

Construction

Advantages

Disadvantages

Improvements/ variations

Cost/ labour

Latrine with a curtain for privacy made of light cloth

- Easy to open and close
- Does not obstruct internal space
- Useful temporary solution

- Easily damaged
- Very little provision for security or privacy

- Non-door alternatives include spiral-shaped entrance for greater privacy

Low

Outward-opening tin door on wooden frame. Raised platform edge acts as a door stop.

- Outward-opening door does not obstruct internal space
- Horizontal wooden struts can be grasped to close door

- Pulling a door is harder than pushing it open
- Requires a wide, level area in front of door for users to position themselves to open the door

- Add horizontal handrail

Medium

Outward-opening wooden double doors with a latch on outside to keep closed

- Easier to close for some users
- Each door is narrow so less obstructive to passers by

- Higher cost than a single door
- Some users find them difficult to use

- Varnish/paint wood to reduce risk of termite damage
- Move bolt to the inside

High



Door handles and closing mechanisms



Door handles and closing mechanisms

Suitable for: everyone, especially women and girls.

Construction

Advantages

Disadvantages

Improvements/ variations

Cost/ labour

**Horizontal handrail
the full width of the
door on the inside.
Internal bolt.**

- User can easily reach
- Door can be bolted to increase privacy
- Large, chunky bolt is easy to operate

- Door must be solid enough to fix the rail to
- Needs monitoring to ensure it is securely fixed and that the bolt slides easily

- Rail could be made of wood (2nd photo, left), g.i. pipe, chain, or cord

Medium

**Carved wooden
handle nailed to the
inside of the door**

- Easy for all users to grasp
- Materials locally available
- Easy to construct

- Does not keep the door closed

- Add a bolt or hook to fasten the door closed
- Handle could also be fixed to the door frame for support when entering

Low

**Metal hook and eye
on inside of door**

- Ensures privacy
- Easy to install
- Materials locally available

- Can be too fiddly for some users to operate

- Instead of a hook, wire can be looped over a bent nail, or a loop of string wound round a bent nail.

Low to medium



Internal Space





Internal Space

Think about: who will use the toilet, and how much space they will need.

Level 1: Space for users who can stand and enter using support rails, or blind users.

Level 2: Additional space for a carer, to use crutches/sticks or to park a wheelchair but not turn.

Level 3: Space for a wheelchair to enter, shut the door, and turn around inside.

	Construction	Advantages	Disadvantages	Improvements/ variations	Cost/ labour
	Traditional round superstructure, cement seat, wooden handrail each side, curtain for privacy	<ul style="list-style-type: none"> Level 1 access: enough space for this household, including a user who needs to use handrails for support. 	<ul style="list-style-type: none"> Curtain only (no door) so privacy is not ideal No space for a carer to accompany 	<ul style="list-style-type: none"> Increase size of the superstructure between the seat and entrance, to allow a carer and user to turn easily Install a door 	Medium
	Entrance corridor, with wall on left in front of latrine and a gap between corridor and toilet.	<ul style="list-style-type: none"> Level 2 access: wheelchair can enter and park in corridor. User can transfer to the toilet using handrails fixed to the inside wall. 	<ul style="list-style-type: none"> Not enough space for a wheelchair to turn easily Wheelchair is visible from outside, so lacks privacy 	<ul style="list-style-type: none"> Install a door or curtain to hide the wheelchair from view 	Medium to high
	Spacious toilet cubicle, with drop hole located in the corner to provide maximum usable space	<ul style="list-style-type: none"> Level 3 access: enough space for wheelchair to enter, turn, close door, and park by the toilet Space for a carer, and/or toilet chair to be moved to one side when not in use 		<ul style="list-style-type: none"> Handrails on the inside to provide support when transferring to the toilet 	High

Floor finish



Movable pit-hole cover

Cement sanplat with footplates

Earth floor



Wooden, movable toilet seat

Latrine pit

Rammed floor without small stones



Raised, static toilet seat

Rammed floor made from small stones and sand; finished with cow dung to make it smooth

Movable pit-hole cover

Floor finish

Think about: the balance between hygiene and safety. Floors need to be smooth enough to be washed and swept, but not so smooth that they are slippery when wet.

Construction	Advantages	Disadvantages	Improvements/ variations	Cost/labour
--------------	------------	---------------	-----------------------------	-------------



Rammed earth floor without marram

- Materials locally available
- Sweepable but not washable

- Difficult to get the floor texture right: see above
- Floor dusty and not very hygienic
- Not easy to clean

- Ensure good water drainage away from the user
- A slightly rough floor is suitable for people using crutches/sticks.

Low



Rammed earth floor made of marram (small stones) and sand; cow dung is smeared over to make it even and smooth.

- Materials locally available
- Repels urine to a certain extent
- Sweepable and wipeable

- Difficult to get the floor texture right - see above
- Easier to keep clean than above example
- Needs regular maintenance (smearing with cow dung)

- Ensure good water drainage away from the user
- A slightly rough floor is suitable for people using crutches/sticks.

Low to medium



Cement slab, installed level with earth floor around it

- Locally produced
- Easy to keep clean - washable
- Durable

- If the surface is too smooth it can be slippery when wet
- Surrounding floor might need maintenance to keep it level with slab

Medium

Handrails and support



WaterAid/Stephen Segawa



WaterAid/Stephen Segawa







WaterAid/Stephen Segawa



WaterAid/Jane Wilbur

Handrails and support

Suitable for: People who are unstable or unable to walk, squat or stand unaided

Construction	Advantages	Disadvantages	Improvements/ variations	Cost/ labour
 <p>Bricks protruding from wall for support to a weak or visually impaired person</p>	<ul style="list-style-type: none"> • Easy to construct • Materials locally available 	<ul style="list-style-type: none"> • Walls must be strong enough to support user's weight • Difficult to add after construction • Regular maintenance needed to ensure stability 	<ul style="list-style-type: none"> • Half bricks in the wall can also provide mini-ledges for a user to hold on to 	Low
  <p>Wooden/ bamboo support rails fixed to floor either in front or on either side of toilet (depending on user's needs)</p>	<ul style="list-style-type: none"> • Materials locally available • Easy to construct and maintain • Allows user to transfer to the toilet from the side • Position and height of rails must involve user and an assessment of their need 	<ul style="list-style-type: none"> • Rails must be strong enough to bear users' weight • Not possible to fix to a concrete floor/slab • Might be difficult to keep clean • Cannot fix to a concrete floor/slab 	<ul style="list-style-type: none"> • Varnish/paint rail to stop termite damage and for easy cleaning • For a growing child use longer vertical poles, so bar height is adjustable. • Horizontal bars at different heights might suit some. • For concrete floors, pipe rails can be cemented in during construction, or screwed to floor later. 	Low
 <p>Metal bars (e.g. galvanised iron pipe) fixed to side wall/s of latrine</p>	<ul style="list-style-type: none"> • Highly durable • Can be added to existing facility • Easy to clean • Bars to be positioned based on user needs 	<ul style="list-style-type: none"> • Walls must be strong enough to fix bars to • Walls must be close enough for user to reach the bars 	<ul style="list-style-type: none"> • Paint bars to reduce corrosion and increase durability • Several bars at different heights on each side might better suit some users 	Medium to high

Credits (top three): WaterAid/Stephen Segawa; bottom: WaterAid/Jane Wilbur

Fixed seat pan



Fixed seat pan

Suitable for: people who have difficulty squatting, including overweight people, pregnant women, older people and disabled people.

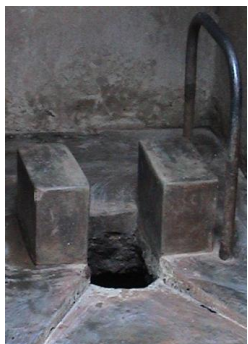

Construction

Twin cement-plastered brick sitting blocks

Advantages

- More comfortable than it looks!
- Gap makes anal cleansing easy
- Smooth cement plaster easy to clean and more hygienic

Disadvantages

- Might be uncomfortable if gap between blocks is not right for the user
- Blocks less stable than a seat so need careful installation

Improvements/ variations

- Paint blocks to repel urine and make them easier to clean
- Install blocks at an angle to suit different users

Cost/ labour

Low



Brick seat with a cement screed

- Durable
- Comfortable

- Narrow drop-hole may be hard to use hygienically by different sized users
- Narrow drop-hole makes inner walls hard to clean

- Paint the seat to repel urine and make it easier to clean
- A wider drop hole would be easier and more hygienic for most users

Low to medium



Cement bowl made with mould

- Comfortable
- Durable
- Easy to wipe, therefore hygienic

- Requires a mould and is more difficult to construct
- Heavy, so needs a strong sanplat

- Paint the seat to repel urine and make it easier to clean

High

Moveable seats

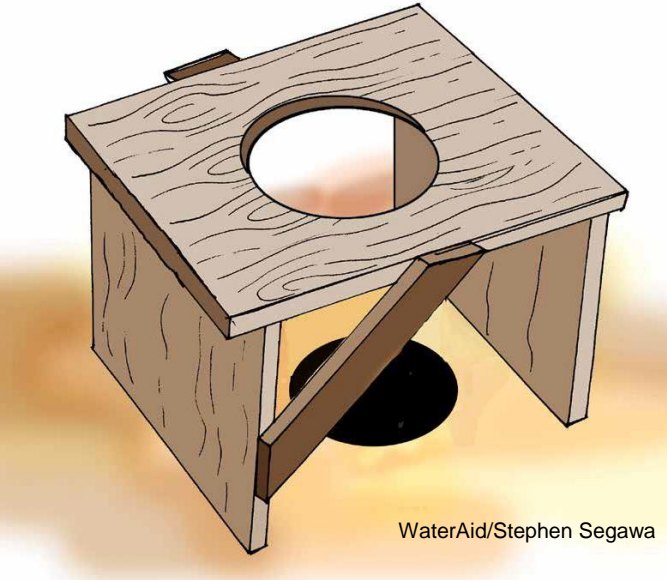
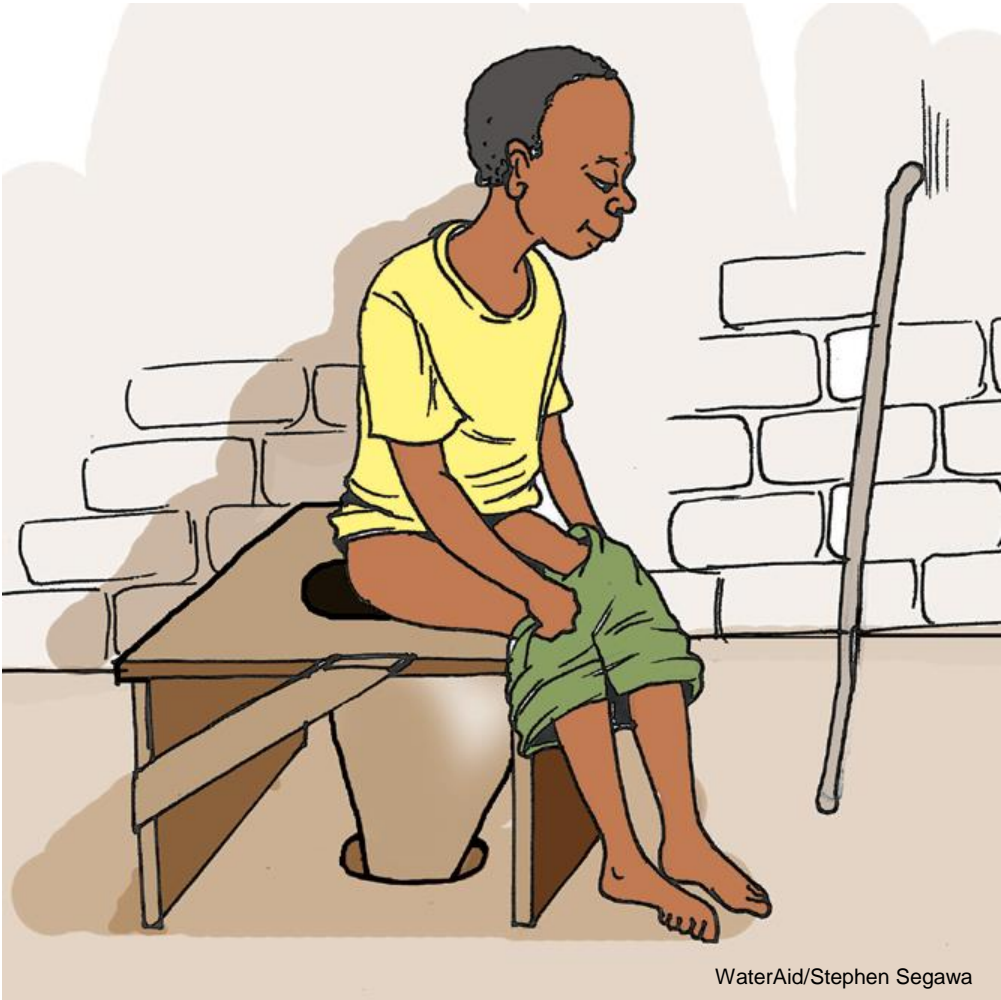

Moveable seats

Suitable for: users who have difficulty squatting, including overweight people, heavily pregnant women, older people, disabled people ...

Construction

Advantages

Disadvantages

Improvements/ variations

Cost/ labour

Low wooden or bamboo toilet stool with hole in seat, placed over toilet hole, with or without funnel as a splash guard (see lower image)

- Easy to construct
- Materials available locally
- Height must be decided based on user's needs
- Can be moved to one side out of the way of other users who prefer to squat
- Light and easy to carry if necessary

- Potential for termite damage
- Enough space needed inside latrine to move the seat away from the pit when not in use

- Painting or varnishing would make it more durable, easier to clean and more hygienic.

Low

Standard varnished wooden chair with hole cut in the seat

- Comfortable
- Provides back support while seated
- Materials available locally
- Varnish makes chair easier to clean so more hygienic

- Needs accurate positioning to reduce risk of splashing or soiling
- Needs extra space in the latrine so it can be moved to one side when not in use
- Might be heavy

- Add a splashguard to the front.
- Add 'runners' - horizontal bars joining the bottom of the legs to better distribute the weight on the floor, to reduce damage (see right).

Low

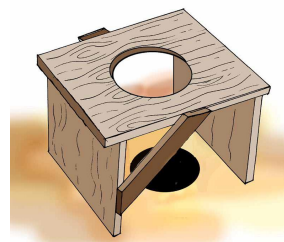

Commode seats



Jones and Reed (2005)



Jones and Reed (2005)

Commode seats

Suitable for: people who cannot reach a latrine; small children.

Construction

Advantages

Disadvantages

Improvements/ variations

Cost/ labour

Painted wooden chair with 'potty' inserted in hole in seat. Potty is removed for emptying.

- Can be placed in the most convenient place for the user or carer, either inside or outside the house
- Fabric straps support a user with poor balance

- Container must be emptied and cleaned after every use
- A separate private toilet area might need to be created
- Wood needs regular painting/varnishing

- Padding can be added to back and sides for extra comfort
- Seat could be used without the potty, placed over the toilet hole
- A bucket could be used under the seat instead of a potty

Low to medium

Metal commode chair with plastic inset toilet pan (bought in local market). Container is placed beneath the seat and emptied into the latrine.

- Painted metal and plastic are strong, durable and easy to clean
- Can be placed in the most convenient place for the user or carer, either inside or outside the house

- Container must be emptied and cleaned after every use
- A separate private toilet area might need to be created
- Metal is uncomfortable for some users – a home-made padded ring could be added for comfort
- Plank and waist belt added to provide extra support

- Car tyre inner tube could also be used as a cushion

Medium to high



Siting

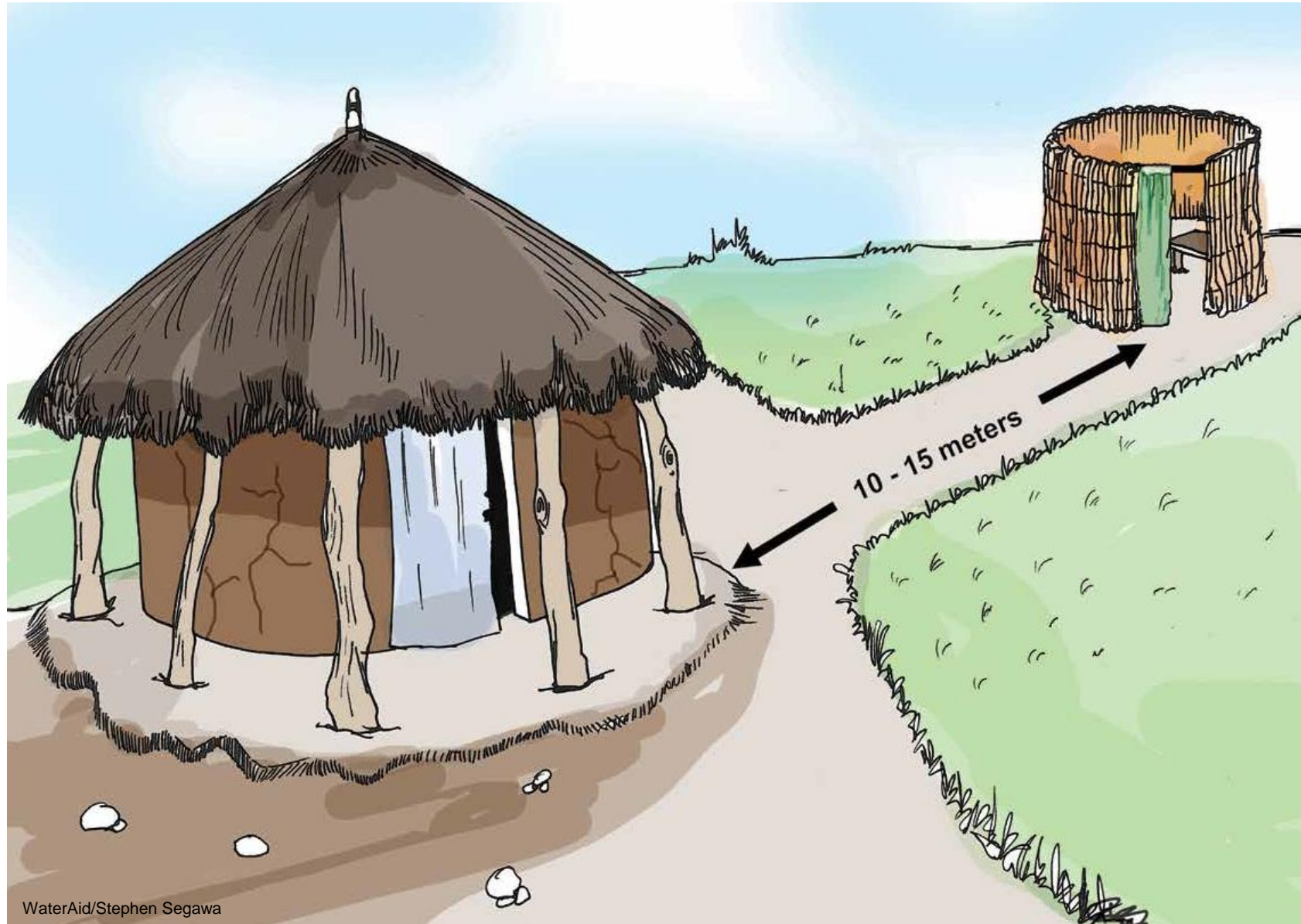

WaterAid/Stephen Segawa

Page deliberately left blank

Water provision

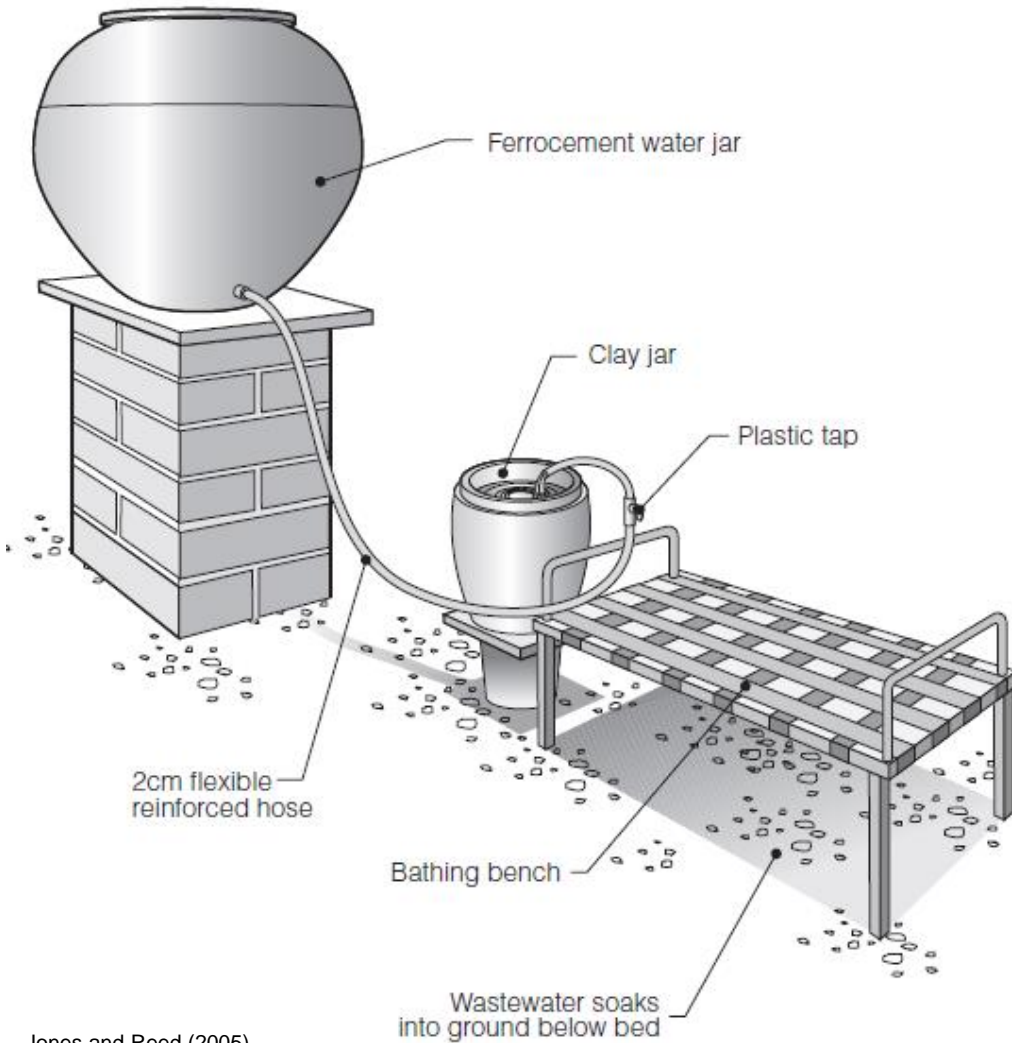

Jones and Reed (2005)

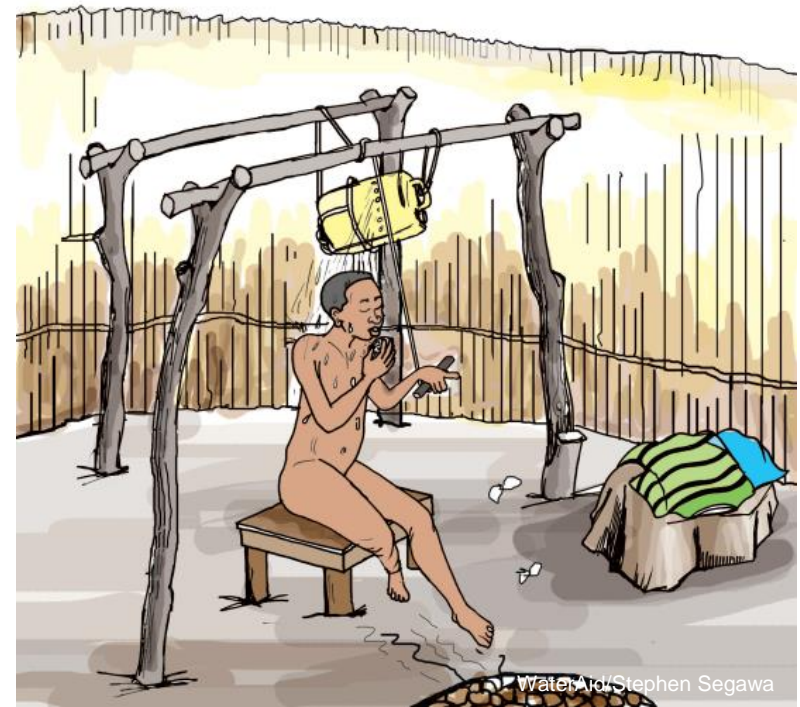

WaterAid/Stephen Segawa



WaterAid/Jane Wilbury

Water provision

Suitable for: people who have difficulty carrying water; people who prefer to sit while washing

Construction

Advantages

Disadvantages

Improvements/ variations

Cost / labour

Elevated large water storage jar with flexible hose, with tap to smaller secondary jar placed next to bathing bench. Water fed by gravity.

- User does not need to carry water
- Bather can fill secondary water jar when required, using tap to control water flow at point of use
- Main water jar filled by rainwater harvesting, or by other family members at their convenience

- Requires space and regular maintenance
- Relies on rainwater; in dry season large jar must be filled by hand

- A bathing screen would normally be placed around the bathing area
- Storage tank could be made of locally available materials

Medium to high

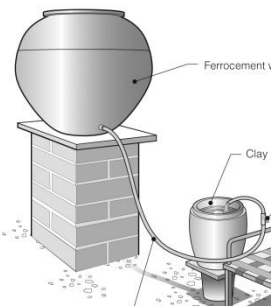

Plastic water container hung high in bathroom, and tipped forward by pulling rope so water flows onto bather.

- User does not need to carry water
- Container can be filled by other family members at their convenience

- Needs to be filled regularly
- Height makes it inconvenient to fill

- Could also be installed in a toilet to provide water for anal cleansing/handwashing
- Connect plastic hose and tap for more controlled water flow

Medium



Basin/bowl placed on wooden table to raise it to a convenient height for the bather.

- Low cost
- Little maintenance required

- Bathers are unable to fill basin themselves so are dependant on others to refill it each time they need it

- Basin could be placed on large, flat stone, or a wooden stand

Low



Seats



WaterAid/CoU-TEDDO



WaterAid/Stephen Segawa



Jones and Reed (2005)

Seats

Suitable for: bathers with difficulty standing to bathe, e.g. poor balance, mobility difficulties, stiffness, heavily pregnant, high fever

Construction

Advantages

Disadvantages

Improvements/ variations

Cost/ labour

Stone seat

- Locally available materials (e.g. stones, concrete slab)
- Durable, strong
- Repels water, easy to clean

- Stones could be heavy so hard to move
- Might be rough and uncomfortable

- Use bricks plastered with cement screed or clay paste to make seat smooth
- Inflated inner tube can be placed on rock for comfort

Low

Wooden stool or chair

- Seat made or bought locally according to the user's specifications

- Seat lacks drainage
- Unfinished wood will deteriorate quickly

- Seal wood with paint/varnish to make it waterproof
- To improve drainage, replace solid seat with slats, or add holes in seat (see right)

Medium

Metal framed bathing bench with woven seat made of recycled tyre inner tubes

- Soft seat is comfortable to sit
- Rubber repels water
- Webbing provides good drainage

- User sinks into seat, so can be difficult to get up without support
- Might start to sag with extended use

- Wood frame instead of metal

Medium



Bathing equipment

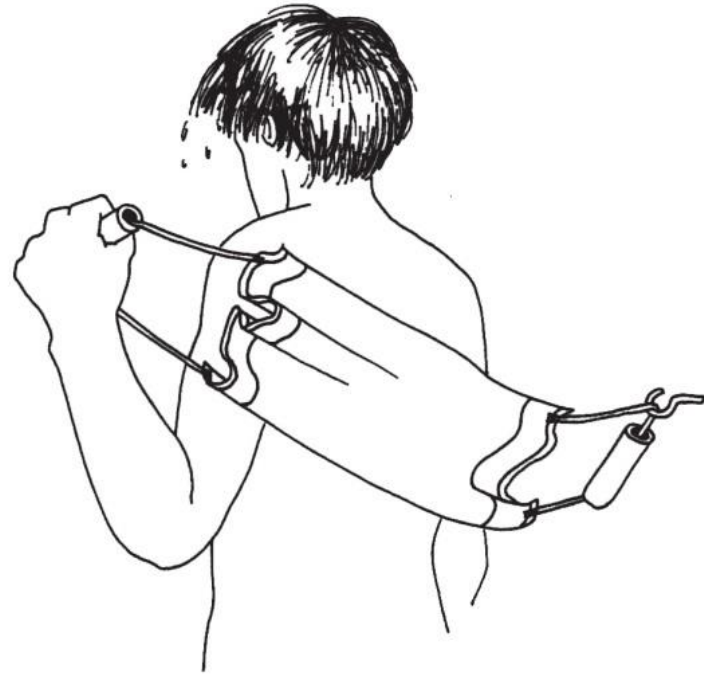

Van der Hulst et al (1993)



Bathing equipment

Suitable for: all users



Construction

Hanging string for clothes (ideal height is 1.2 m)

Advantages

- Made from locally available materials
- Can be installed at a height suitable for users

Disadvantages

Improvements/ variations

- A wooden pole or a rope can be used
- The line could also be used to hang a privacy curtain

Cost/ labour

Low

Towel or cloth with a loop or handle at each end. One end is attached to a fixed point, to make it easy to use with one hand.

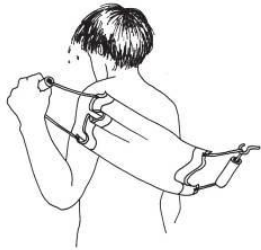

- Made from locally available materials

- If a longer towel is used, one loop can be held with a foot
- For a user with no hands, both ends can be fixed

Low

Bathing sponge: made of old fishing net and sisal wrapped around a stick and tied with a piece of bicycle tube



- Made from locally available materials

- Not durable

- Any kind of soft material could be used
- Can be adapted for anal cleansing use (and then used solely for that purpose)

Low

Apron layout



WaterAid/DAPP



WaterAid/Ernest Randriarimalala



WaterAid/CoU TEDDO

Apron layout

Suitable for: all users

Construction

Advantages

Disadvantages

Improvements/ variations

Cost / labour

Medium

Community borehole apron with wide circulation area and pedestal for container

- Offers a choice for users of where to stand or sit to operate pump handle
- Pedestal for container next to water spout
- Drainage channel is in opposite direction from user

Community tapstand with wide entrance and enlarged circulation area with raised edges (still under construction)

- Layout provides ample space for users to enter and turn easily
- Raised edges prevent a wheelchair from rolling off the side of the apron

- Layout is not suitable for handpumps
- User approaches tap from one side. To approach from other side requires a 180° turn.
- Drainage hole could become blocked, leading to excess water on apron

- A concrete ramp instead of gravel at the entrance will improve access when construction is complete

Medium

Community borehole with wide circulation area added to usual circular apron with raised edge

- Additional space enables a person with a mobility device to choose position to operate the handpump from
- Raised edge round handpump reduces water on apron/provides a resting place when lifting container

- Raised edge restricts access to placing and retrieving water container

- Can be added to existing borehole structures

Medium



Apron access via concrete ramps



WaterAid/CoU-TEDDO



World Vision Mali



WaterAid/Jane Wilbur

Apron access via concrete ramps

Suitable for: people using mobility devices, e.g. wheelchairs, crutches, sticks, people carrying heavy loads

Construction

Advantages

Disadvantages (all disadvantages apply to all examples of ramps)

Improvements/ variations

Cost/ labour

Concrete ramp to access borehole apron

- Provides independent access to apron platform for wheelchair users
- Improves access for everyone

- Maintenance needed to keep surrounding ground the same level as the end of the ramp
- Drainage must be in the opposite direction to keep the ramp dry

- Paint raised sides white or a bright colour to make them more visible

Medium
(as a proportion of overall installation)

Concrete ramp to access handpump apron

- As above

- Ramp might need more space than steps
- Monitoring is needed to ensure masons do not build ramp too steep to reduce cost. (For guidance on gradients, see page 7.)

- Cross-hatching on ramp would ensure it is not slippery when wet (For an example, see page 10.)

Medium

Concrete ramp to access borehole apron

- As above

- As above

As above

Medium



Pump handles



Messiah College Collaboratory



Norman (2010)



WaterAid/Jane Wilbur

Pump handles

Suitable for: users with limited strength or grip

Construction

Advantages

Disadvantages

Improvements/ variations

Cost / labour

Bent T-bar with tube which slips over the end of a standard pump handle. A screw keeps it in place.

- Provides extra leverage which makes pumping easier
- Provides choice of position to operate handle from: front or side

- Might invalidate pump warranty

Medium

Prototype of adapted pump handle being trialled in conjunction with a concrete seat

- Can be operated from either side or the front, according to user preference
- Seat is located to one side, so as not to obstruct standing users

- Much heavier than standard handle
- Handle not liked by community who feared children could be hit on the head

- Based on testing with local users, this handle has been rejected in favour of the P-handle below (but is included for interest).

High

P-handle with a hollow pipe that slides over the end of India MK II pump handle and is kept in place with screws

- A completely new handle is not needed
- Local artisans can be trained to make P-handle
- Can be operated from the side or front according to user preference

- India Mk II handles vary, so artisans must be trained to tailor adaptation to handle dimensions
- Not applicable to other handpumps, e.g. Afridev

- CAD drawing of the P-handle:

Initially high (training required); subsequently medium

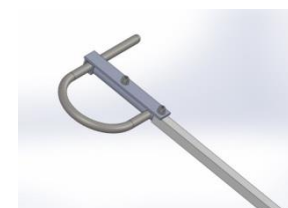

Lifting water containers



WaterAid/Jane Wilbur



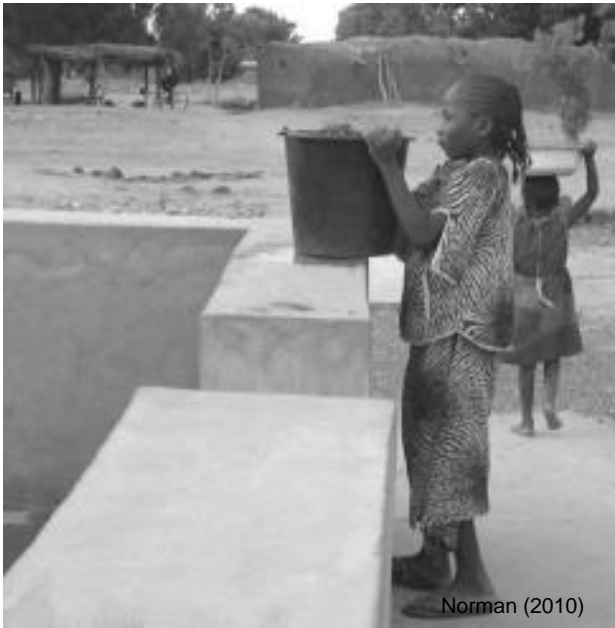

WaterAid/WEDA



Norman (2010)

Lifting water containers

Suitable for: all users, especially those with limited strength, difficulty balancing or difficulty grasping a container.

	Construction	Advantages	Disadvantages	Improvements/ variations	Cost/ labour
	Pedestal made of bricks plastered with cement screed. Height about 70cm (adult hip height).	<ul style="list-style-type: none"> Lifting the container from floor to head can be split into two separate actions by resting the container midway. 		<ul style="list-style-type: none"> Height is ideally decided based on testing and feedback from local users (carrying out accessibility audits). 	Low
	Pedestal made of bricks plastered with cement screed. Height about 45cm (adult knee height).	<ul style="list-style-type: none"> As above Lower stand is easier for children and shorter people to use than 70cm pedestal 		<ul style="list-style-type: none"> Height is best decided based on testing and feedback from local users. 	Low
	Borehole enclosure wall used as a midpoint for resting water container	<ul style="list-style-type: none"> As above User can rest the container, walk to the outside of the wall, and pick it up from there 	<ul style="list-style-type: none"> Wall must be very sturdy to support heavy containers of water 		High

Transporting water



Transporting water

Suitable for: people using mobility devices, poor balance or strength



Construction

Transporting a 20L jerry can of water on wheelchair footrests

Advantages

- Jerrycan is in an easy-to-access position

Disadvantages

- Jerrycan can only be part-filled, otherwise the weight of the water risks tipping the chair
- Jerrycan reduces space for feet

Improvements/ variations

Cost/ labour

Low



20L jerry cans carried on a rack under the seat of a tricycle

- Weight is low down and no risk of tipping the chair

- Rack under the seat might be difficult to access

- A rack behind the seat could be easier to access for some people.

Cost of tricycle is high



Small jerry can carried using a hook attached to the crossbar of a crutch

- Avoids difficulty of holding crutch and container at the same time

- Extremely difficult to lift if using only one crutch

- Jerrycan could be placed on the head or in a basket on the back instead

Low

Accessing stored water



Messiah College Collaboratory



WaterAid/Stephen Segawa



Hazel Jones/WEDC

Accessing stored water

Suitable for: children, people with limited strength, difficulty bending or lifting, poor balance, or the use of only one arm

Construction

Advantages

Disadvantages

Improvements/ variations

Cost/ labour

Water stored in a bucket accessed via a tap near the bottom

- Tap enables controlled flow and low risk of contamination
- Wide opening of bucket is easy to fill
- Tight-fitting lid reduces risk of contamination

- Might not be on sale locally

Medium

Tin can used to dip and draw water from a covered

- Can or cup is widely available
- No construction needed
- System can be used with any size of container, e.g. the bucket above

- Storage jar located outside the house so less convenient than inside
- Potential for water contamination from dipping can

- Add a handle to the tin or cup to reduce risk of contamination
- Raise the jar and fit a tap to avoid frequent removal of cover
- Use light materials for cover

Low

Jerrycan tipper made of square, light gauge, iron tubing

- Enables a person to easily pour water from a jerrycan
- Robust and durable
- Easy to use

- Similar tipper can be constructed for a bucket
- Can be made more cheaply from wood held together with wire

Medium



Handwashing

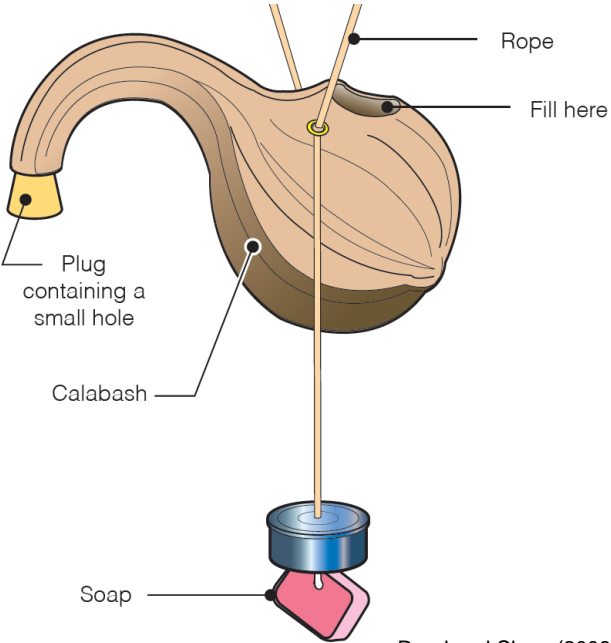

Reed and Shaw (2008)



Handwashing

Suitable for: all, especially people with weak legs or the use of only one hand

Construction

Advantages

Disadvantages

Improvements/ variations

Cost/ labour

5L jerrycan with hole(s) pierced near the top, hung from a rail. Jerrycan is tipped by pressing a foot on a stick attached by a string to the lid.

- Easy to construct using local materials

- Difficult to use if person cannot use their feet

- Needs to be regularly filled with water

Low

Suspended gourd; large hole for filling, small hole in plug for pouring

- Locally available
- Easy to make

- Not very durable

- Needs to be regularly filled with water

Low

Cut-away jerrycan; water is scooped out with a 'ladle' made of a plastic aerosol lid fixed to a stick

- Made with locally available materials
- Operated with hands instead of feet

- Open to contamination

- Put lid or cover on top, e.g. using cut out section of can
- Ladle could be pierced with holes so water trickles out when it is suspended. It can then be used with one hand.

Low

1L plastic bottle with ballpoint pen casing inserted via a hole near the bottom. Water flows when lid is loosened, stops when lid tightened.

- Easy to make using locally available materials
- Operated with hands instead of feet

- Needs constant refilling
- Difficult to refill
- Bottle top gets lost

- The bottle could be replaced with a jerrycan to reduce the frequency of refilling, as long as the lid was tight-fitting.

Low

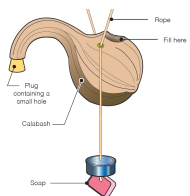

Further resources

Resource	Overview	Location
WEDC Equity and Inclusion resources	Awareness-raising and training materials. Includes guidance on doing accessibility and safety audits for waterpoints, school and household latrines.	www.wedc-knowledge.lboro.ac.uk/collections/equity-inclusion/
Jones H and Reed R (2005) <i>Water and sanitation for disabled people and other vulnerable groups: designing services to improve accessibility</i> . WEDC, UK.	Accessible WASH designs for people who experience limitations in carrying out activities related to WASH.	https://wedc-knowledge.lboro.ac.uk/details.html?id=16357
Reed R and Shaw R (2008) <i>Sanitation for Primary Schools in Africa</i> . WEDC, UK.	Guidelines for primary school sanitation in Africa.	http://wedc.lboro.ac.uk/resources/books/Sanitation for Primary Schools in Africa - Complete.pdf
Wilbur J and Jones H (2014) <i>Disability: making CLTS fully inclusive</i> . Frontiers of CLTS: innovations and insights, Issue 3, IDS, Brighton.	Short booklet highlighting experiences of disabled people, with practical recommendations for how to make the CLTS process fully inclusive (available in English, French and Portuguese).	www.communityledtotalsanitation.org/resource/frontiers-clts-issue-3-disability-making-clts-fully-inclusive
Appropriate Technology Centre (2014). <i>A practical guide for inclusive WASH services at household and community level in Uganda</i> .	Technical guidance for making WASH facilities more accessible.	To be published
Ray Normal (2010) <i>Water sanitation and disability in W Africa</i> . Phase 1 Report. The Africa WASH and Disability Study - The Collaboratory at Messiah College.	Partnership with World Vision to improve access to safe water, especially for disabled people, in West Africa. Reports, videos and technical drawings available in Additional Resources.	http://www.africawashdisability.org/ For resources go to >About us >Partners & Additional Resources

This compendium was developed in collaboration with:



This material has been funded by UK aid from the Department for International Development (DFID). However, the views expressed do not necessarily reflect the Department's official policies.